

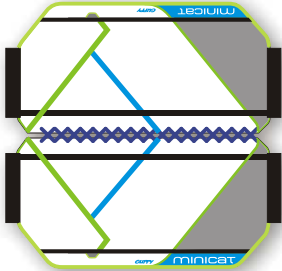









2021
ISSUE

MINICAT GUPPY
PARTS AND ACCESSORIES

minicat
ULTRA LIGHT CATAMARAN



FLOAT		TRAMPOLINE		CENTER FRAME	
right	30001	right	30003	30005	
left	30002	left	30004		
 <p>Weight: 7,5 kg</p>				 <p>Weight: 2,3 kg / 166 x 18 x 10 cm</p>	
BOWSPRIT		CROSS TUBE		SIDE TUBE	
 <p>Weight: 0,5 kg / 58 x 6 x 7 cm</p>		front	30007	30009	
		rear	30008		
 <p>Weight: 1,5 kg / 145 x 4,5 x 6 cm</p>		 <p>Weight: 0,4 kg / 115 x 2,5 x 4 cm</p>			
RUDDER BLADE		RUDDER ASSEMBLY		FIDDLE BLOCK CLEAT	
 <p>Material: HDPE Weight: 1,3 kg / 70 x 20 x 1,5 cm</p>		 <p>Stainless steel Weight: 0,6 kg / 160 x 18 x 3 cm</p>			
MAST		SAIL		SHROUD	
 <p>Weight: 1,1 kg / 140 x 6 x 7 cm (each part) *1 - lower part, 2 - centre part, 3 - upper part</p>				 <p>Stainless steel</p>	

KEEL FIN	30016	PINTLE	30017	RUDDER PIN	30018
----------	-------	--------	-------	------------	-------



Polypropylene
Weight: 0,6 kg / 56 x 18 x 5 cm



Stainless steel, diameter: 6 mm

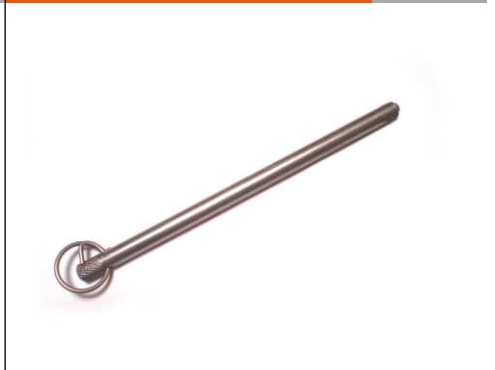

Stainless steel, diameter: 8 mm

JIB CLEAT	30021	MINICAT GUPPY BAG	30023	GUPPY BAG WITH WHEELS	30024
-----------	-------	-------------------	-------	-----------------------	-------

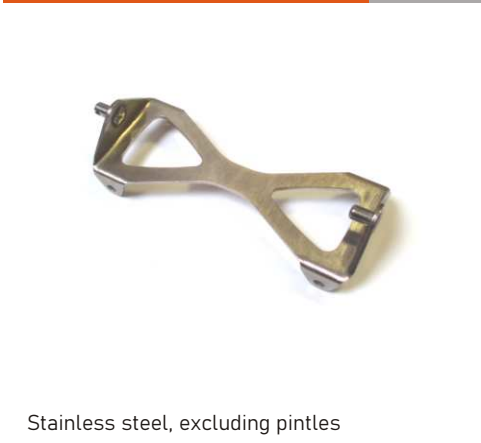

Stainless steel, excluding pintles



Dimension: 175 x 30 x 30 cm
Weight: 1,9 kg



Dimension: 175 x 30 x 30 cm
Weight: 3,9 kg

ADDITIONAL TRAMPOLINE	30043	PROTECTIVE COVER	30044	ENGINE SUPPORT	30045
-----------------------	-------	------------------	-------	----------------	-------

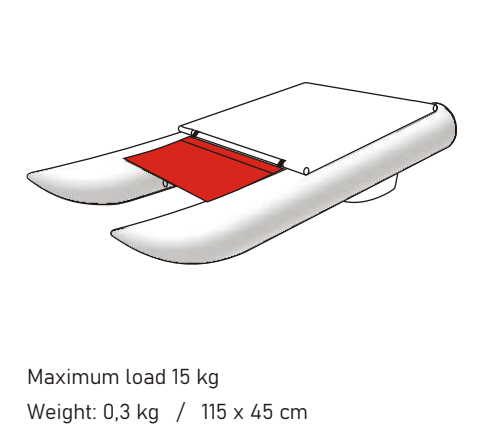

Maximum load 15 kg
Weight: 0,3 kg / 115 x 45 cm

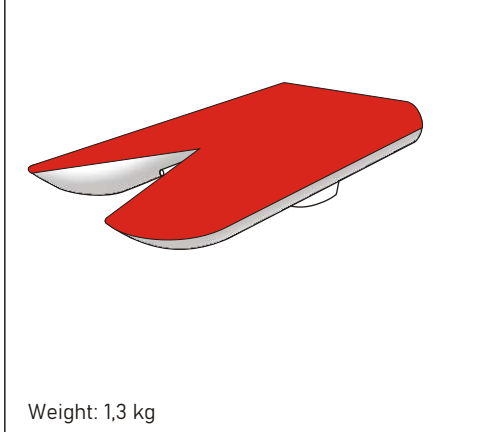

Weight: 1,3 kg



Weight: 1,3 kg / 30 x 20 x 15 cm

BATTENS				SHACKLE		
---------	--	--	--	---------	--	--

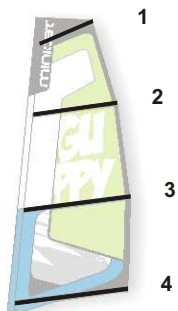







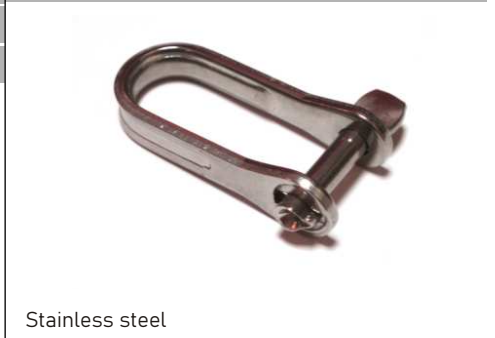





Battens













1 - 720 mm	30046
2 - 1050 mm	30047
3 - 1320 mm	30048
4 - 1390 mm	30049













Ø 5	1000
Ø 6	1002



Stainless steel

SHACKLE M5	1004	SPRING HOOK	RETAINING CLIP
 <p>Stainless steel</p>		50 x 5 mm	1006
		60 x 6 mm	1008
 <p>Stainless steel</p>		 <p>Stainless steel</p>	
 <p>With clip and rivets</p>			
 <p>Stainless steel</p>		CLAM CLIP	Guppy
		310	420 + 460
 <p>Top of the Mast</p>			
TOP SWIVEL	1022	REPAIR KIT	1024
 <p>Two pieces of float rubber material, glue, instructions</p>			
D-RINGS WITH GLUE	1028	FLAG	1030
		 <p>Indicator of wind direction on the top of the mast.</p>	
		 <p>Protection from splashing and short immersion in water</p>	

<p>WATERPROOF SACKS 1034</p>  <p>Sizes: 5l - a 12l - b 23l - c 40l - d</p>	<p>BAG FOR SMALL PARTS 1036</p>  <p>290 x 240 mm Colour: Grey</p>	<p>INFLATION PUMP</p> <p>4 l 1038 6/3 l 1040</p>  <p>4 litres 6/3 litres</p> <p>Weight: 0,7 / 0,9 kg</p>
<p>ADAPTER FOR VALVES 1042</p> 	<p>VALVE 1044</p> 	<p>VALVE WRENCH 1046</p> 
<p>PRESSURE GAUGE 1048</p>  <p>Weight: 0,2 kg</p>	<p>ELECTRIC PUMP 1050</p>  <p>Weight: 1,9 kg The compressor powered by a car battery</p>	<p>RECHARGABLE PUMP 1052 BATTERY CHARGER 1053</p>  <p>Weight: 4,8 kg The compressor powered by a chargeable battery</p>
<p>WINDMETER 1054</p>  <p>Weight: 0,1 kg</p>	<p>CABLE COVER 1056</p> 	<p>NEOPREN SHROUD COVER 1058</p>  <p>Pair</p>

<p>FLOAT SUPPORT</p>	<p>1060</p>	<p>TELESCOPIC PADDLE</p>	<p>1062</p>	<p>MAINTENANCE KIT</p>	<p>1064</p>
					
<p>Pair , aluminium alloy ; Weight: 1,9 kg</p>		<p>Length 500 - 1150 mm ; Weight: 0,4 kg</p>		<p>Lubricant, UV Tech, WD-40, brush sponge, washing rag</p>	
<p>UV TECH</p>	<p>1066</p>	<p>MINICAT BAG</p>	<p>1068</p>	<p>T-SHIRT</p>	<p>1076</p>
					
<p>Protection & Rejuvenator 355 ml</p>		<p>Size: 500 x 300 x 250 mm ; Weight: 1,0 kg</p>		<p>L ; XL</p>	
<p>POLO SHIRT</p>	<p>1078</p>	<p>T - SHIRT</p>	<p>1080</p>	<p>POLO SHIRT</p>	<p>1082</p>
					
<p>L ; XL</p>		<p>L ; XL</p>		<p>L ; XL</p>	
<p>T - SHIRT</p>	<p>1084</p>	<p>T - SHIRT</p>	<p>1086</p>	<p>T - SHIRT</p>	<p>1088</p>
					
<p>M ; L ; XL ; XXL</p>		<p>M ; L ; XL ; XXL</p>		<p>M ; L ; XL ; XXL</p>	

T - SHIRT

1090



M ; L ; XL ; XXL

T - SHIRT

1092



M ; L ; XL ; XXL

T - SHIRT

1094



M ; L ; XL ; XXL

PFD - RED

1100



XL ; XXL
Weight 0,3 kg

PFD - GREEN

1102



XL ; XXL
Weight 0,3 kg